

KRAIBURG Softbed LongLine

Prerequisites:



concrete surface:

- no holes
- no elevations
- min. 3 % slope

mats:

even temperature:
min. 5° C to max. 30° C
(store according to initial temperature)

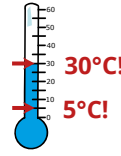

For animal well-being some bedding is necessary to absorb moisture (e.g. soft milled straw or mineral material)

You will need this:

measuring:

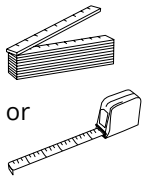

marking:

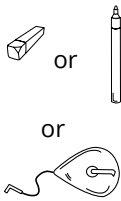

cutting:

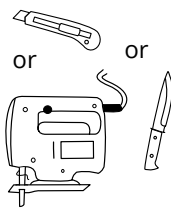

drilling and installing:

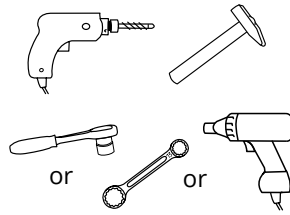

KRAIBURG fixing elements:

- framing plugs \varnothing 10 x 100 mm with
 - hexagon screw (SW 13) - A2
 - washer \varnothing 30 mm - A2
- (fixing elements are part of delivery)

1 Placement lines

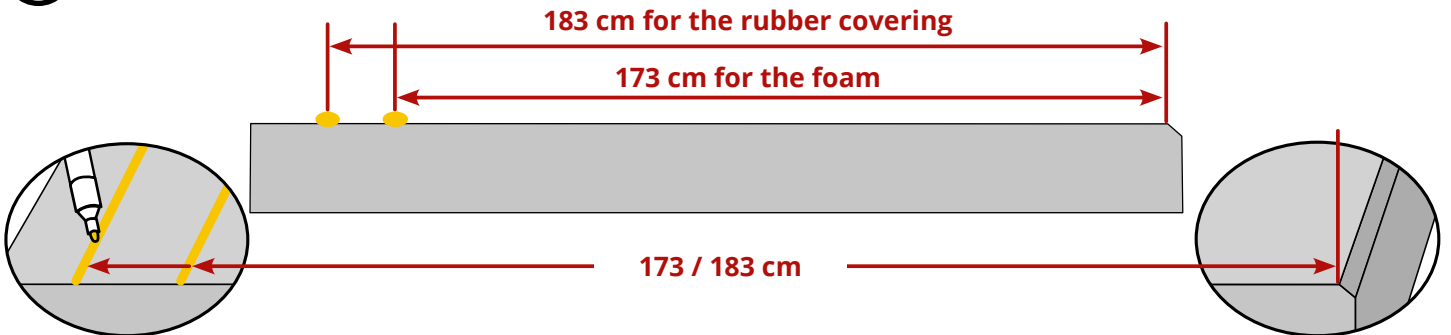

draw placement lines at the front

Tip: use a chalk line

measure from the rear concrete edge

2 Lay out foam

i Position foam along the placement line 173 cm, allow space for the closure bars on the side edges (see step 5)

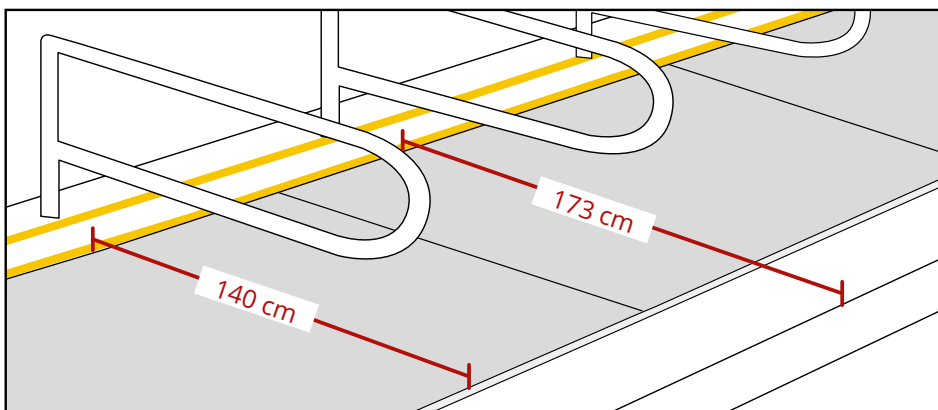

i **Tip for deep dividers:** use a wooden board as a limitation at the front edge to avoid slipping of the foam

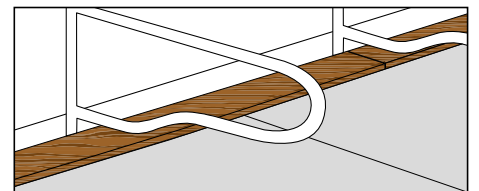

3 Roll out and position rubber covering

roll out rubber covering and position it along the placement line 183 cm

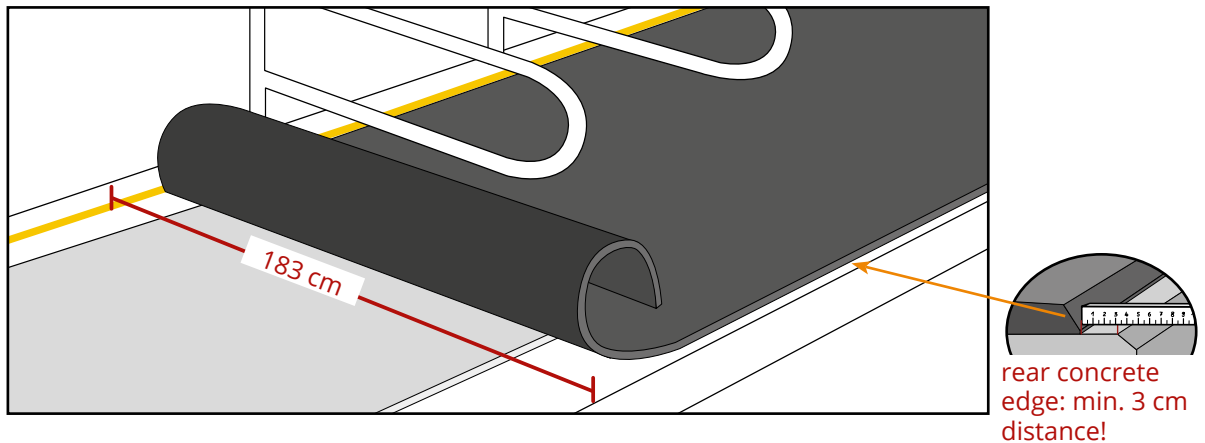

rear concrete edge: min. 3 cm distance!

! Cutting out pockets for pillars etc. is not possible!

4 Fix

i Start from the middle of the roll and fix to the right and to the left.
Recommendation: work from the head space to avoid slipping of the components.

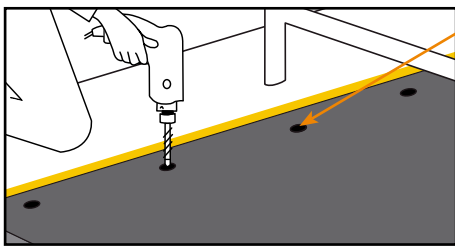

fix at the front edge through the prefabricated fixing points

! Make sure the front edge of the mat is on the marking. Readjust, if necessary.

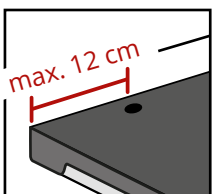

distance between mat edge and last fixing points: max. 12 cm!

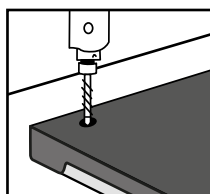

if distance exceeds 12 cm: place an additional fixing point

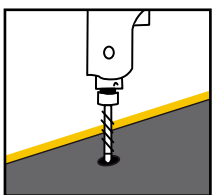

drill

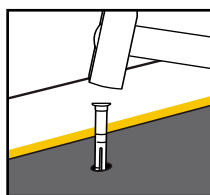

pound the plastic plugs in flush

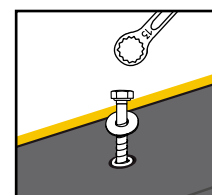

fix screws and washers

! Fix screws until they are seated evenly fast and are slightly countersunk. **Do not overtighten!**

5 Fix side mat edge with closure bar

A Position bars

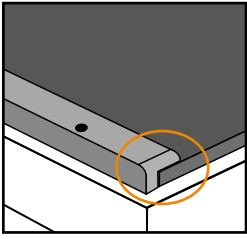

left edge with bar

WELA-L 170 or

WS-L 170

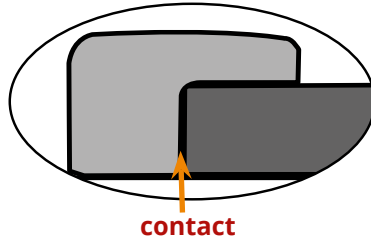

contact

! DO NOT PRESS!

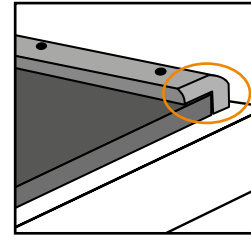

right edge with bar

WELA-R 170 or

WS-R 170

- rounded off end on the rear edge
- flush with rear mat edge

B Fix bars

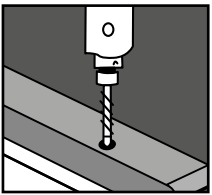

drill

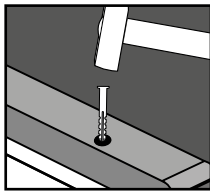

pound the plastic plugs in flush

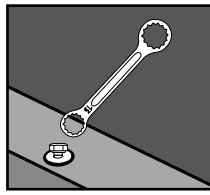

fix screws and washers until they are seated evenly fast; **do not overtighten!**



Tip: avoid slippage:

- fix at one fixing point
- afterwards drill further holes and so on

6 Optional: connect two rolls with a middle bar (under a divider)

A Insert middle bar **WELA-M 170** or **WS-M 170**

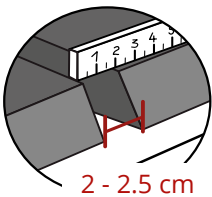

2 - 2.5 cm

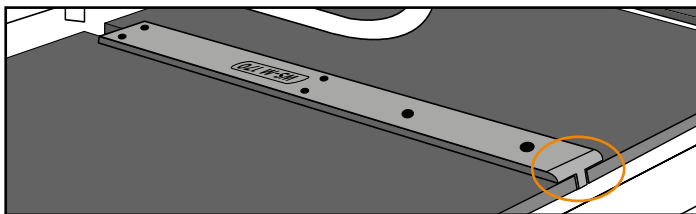

- rounded off end on the rear edge
- flush with rear mat edge



! DO NOT PRESS!

B Fix bars: see 5 B